

Instruction Sheet

Subject: 8263509, 8263560 & 8263561 120V Basket Lift Installation Instructions (Gas)

Models affected: OCF/H55/FilterQuick Gas Fryers

Follow these instructions to install the basket lift kit.

1. Disconnect power and gas from the fryer.
2. Remove the fryer from the hood to gain access to the rear of the fryer.
3. On the rear of the fryer, remove the four (4) side screws towards the outer edge of the fryer (see Figure 1).
4. Using the screws removed from previous step, insert the screws into the holes in the center of the fryer back (see Figure 2) and thread the holes, if not already threaded. Remove the screws after threading.
5. Using the screws removed from step 3 and supplied screws, attach the basket lift assembly (see Figure 3). If any of the holes don't line up, use the supplied self-tapping screws.



Figure 1

6. Insert the supplied cable assembly (1087490) through the opening in the bottom of the basket lift assembly. Connect the male Molex connector to the female Molex connector (see Figure 4).



Figure 2



Figure 3

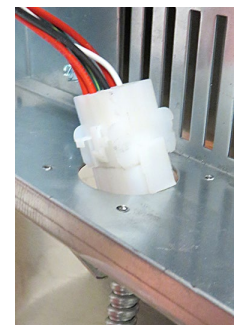

Figure 4

In This Kit		
Part #	Description	Qty
1085394	B/L ASSEMBLY, FPGL MODULAR	1
1084142	B/L ASSEMBLY, H55 MODULAR 120V	1
130154838	B/L ASSEMBLY, H55 MODULAR 208-240V	1
1086946	GUIDE, BASKET LIFT ARM	1
1087490	CABLE ASSY	1
1083454	HARNESS, GAS OCF B/L INTERFACE	1
8072000	HARNESS, H50/52 BL	1
8238842	ARM W/A BL LEFT FPGL	1
8238843	ARM W/A BL RIGHT FPGL	1
8238458	ARM W/A BL LEFT H55	1
8238459	ARM W/A BL RIGHT H55	1
8050518	DIAGRAM, WIRING BL 100/120V	1
2601474	COVER, BASKET LIFT HANGER	2
2401707	COVER FPRE/H55 MODULAR BASKET LIFT	1
2601846	COVER, FPGL MODULAR BASKETLIFT	1
2401693	SHIELD, REAR MODULAR B/L COVER	1
8090047	NUT, CAP 1/4-20 HI-PROFILE SS	4
8090364	SCREW, #8 X 5/8" HX	14
8090361	SCREW, DRILL #8 X 1/2" HX	6
8091101	SCREW, #12X1/2 HX WSHR SL HD Z	4
8090417	NUT, FLNG 1/4-20 SERR	4
8140015	TY WRAP	6
8070834	RELAY BL 15A 12V	2
8262264	KIT, SMT INTFC STD GAS W/BL DV	1
8051964	DIAGRAM, WRNG MOD. B/L 208-250V	1
8197536	INSTRUCTIONS	1

NOTE: Not all parts are included in each kit.

7. Attach the conduit plate to the bottom of the basket lift assembly using 4 supplied screws (see Figure 5).

8. Route the other end of the conduit harness, along

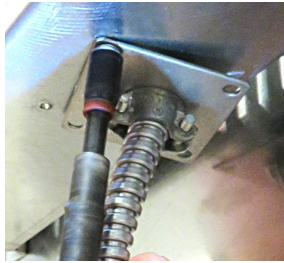

Figure 5

the inside of the fryer, to the front of the fryer (see Figure 6).

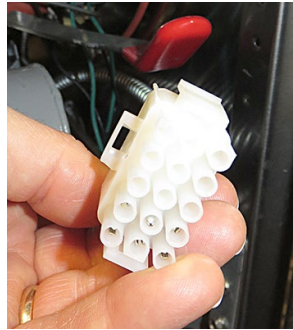

Figure 6

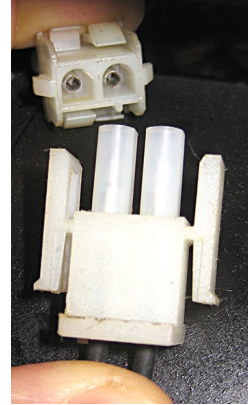

Figure 7

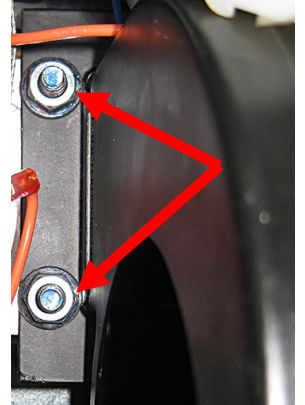

Figure 8

9. Disconnect 2-pin blower power connection (see Figure 7).

10. Remove the blower by removing the four (4) 7/16" nuts (2-left and 2-right) (see Figure 8).

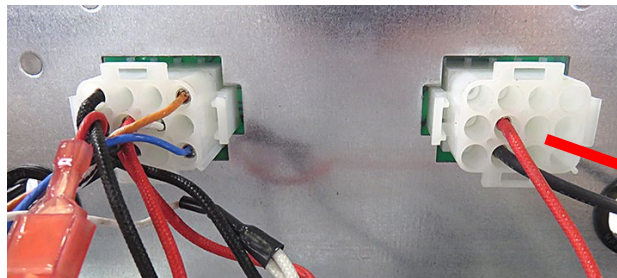

Figure 9

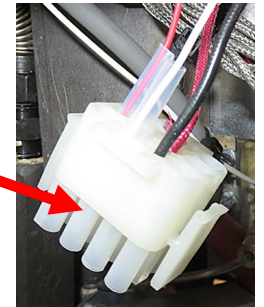

Figure 10

11. On the rear of the control box are two (2) connectors that attach to the rear of the interface board (see Figure 9). The photo is viewed from inside from the rear of the fryer. *Note the Pin 1 is on the lower right corner. From the front of the fryer it would be on lower left.

12. Reach up through opening where blower was removed and locate the plugs shown above in Figure 9.

13. Disconnect the plug located to the left of where your hand is located and gently lower ensuring that no pins are pulled from the plug (see Figure 10).

14. Disconnect the plugs from the front of the interface board and remove and replace the interface board with the new interface board included the kit.

15. Remove the heat relay(s) from the old interface board and attach to the two bottom connectors (K2 and K3) on the new interface board (see Figure 10A).

16. Attach the new basketlift relays included in the kit to the two top connectors (K1 and K4) of the new interface board (see Figure 10A).

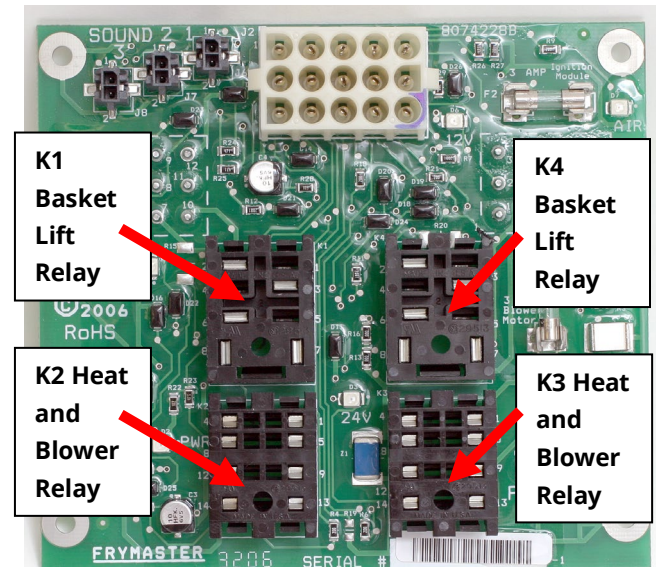

Figure 10A

17. Reattach all plugs on the front of the interface board, removed in step 14, to the new interface board.

18. Locate new 1083454 harness and insert the red wire into pin 7 and the black wire into pin 10 (see Figure 11) of the harness disconnected in step 13. **(Note - Pin 1 is indicated by the ridge in the corner (see Figures 12 and 13)).** Reference drawing on last page of these instructions.

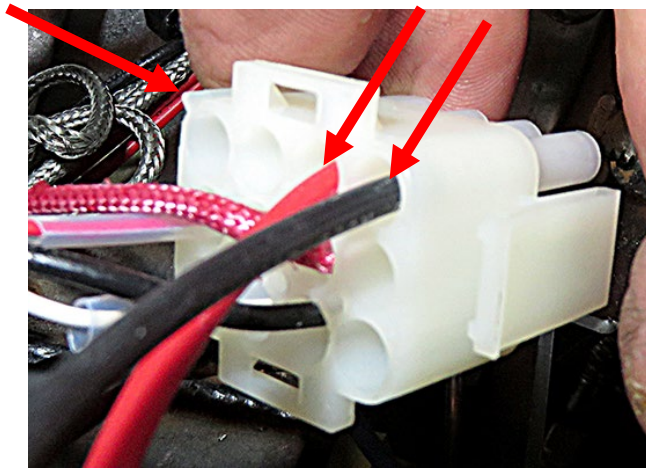

Figure 11



Figure 12

19. Gently tug on the two (2) wires inserted into the connector in the previous step to ensure the pins are fully locked into the connector

20. Reconnect the connector disconnected in step 13 to the rear of the control box.

21. Disconnect the plug located to the right of where your hand is located and gently lower ensuring that no pins are pulled from the plug (see Figure 14).

22. Insert the blue wire from the harness in step 18, to pin 7 and orange wire into pin 10 (see Figure 15) of the harness disconnected in step 21. **(Note - Pin 1 is indicated by the ridge in the corner (see Figures 12 and 13)).** Reference drawing on last page of these instructions.

23. Gently tug on the two (2) wires inserted into the connector in the previous step to ensure the pins are fully locked into the connector.

24. Reconnect the connector disconnected in step 21 to the rear of the control box.

25. Remove the controller bezel (see Figure 16).

26. Remove the two screws, attaching the controller, associated with the basket lift (see Figure 17).

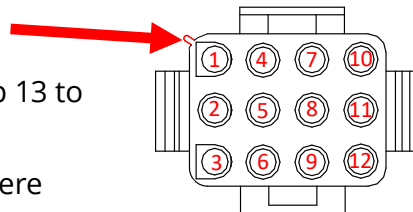

Figure 13
Viewed from the Rear

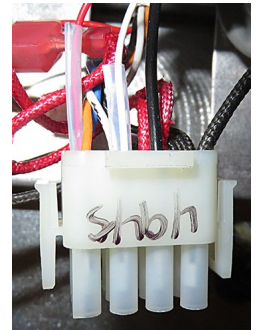

Figure 14

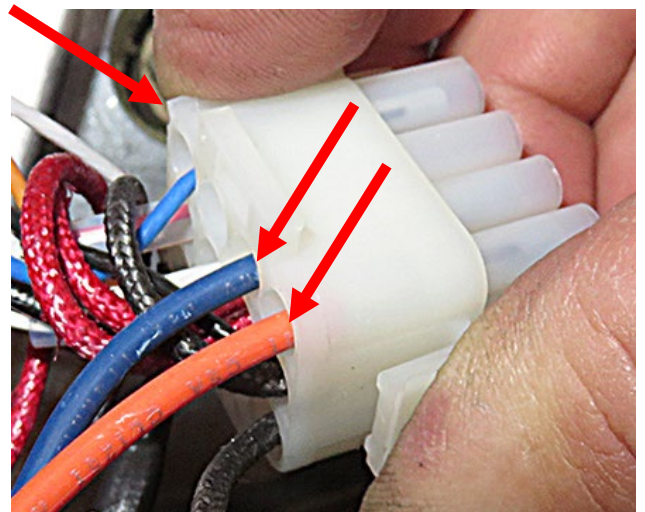

Figure 15



Figure 16

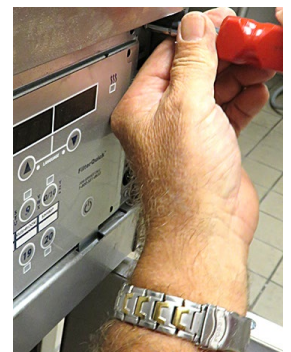

Figure 17

27. Route the green ground wire and the white wire from the new harness from step 18 up through the grommet in the bottom of the control box (see Figure 18).

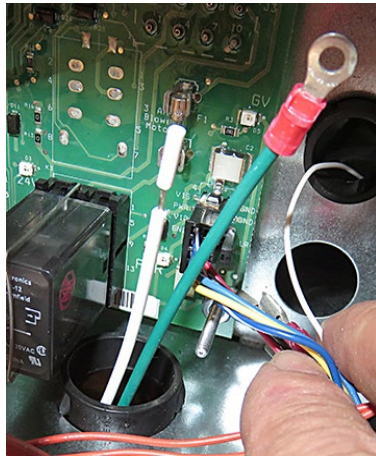

Figure 18

28. Locate the T2 terminal block with the wire wires, in the control box. Press down on the lock of an empty terminal and insert the white wire (see Figure 19) and release the lock. Ensure the wire is locked into the terminal block.

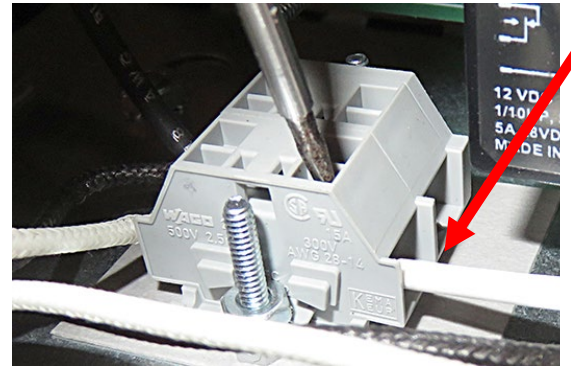

Figure 19

29. Remove a screw from the inside of the control box. Insert the screw into the ground wire eye connector and reattach the screw to the side of the control box (see Figure 20).

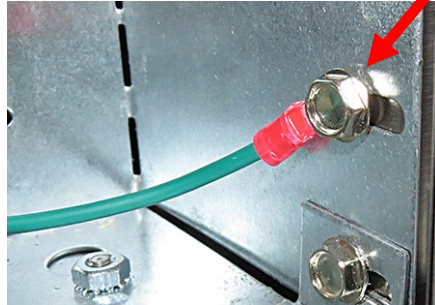

Figure 20

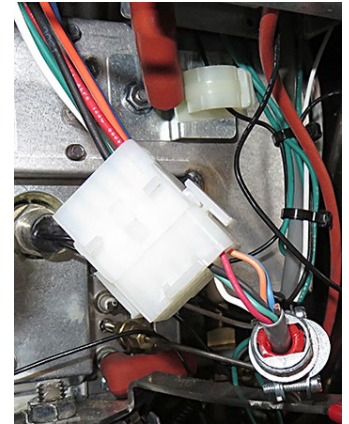

Figure 21

30. Connect the new 1083454 harness female connector to the male connector of the 1087490 harness in step 8, that was routed to the front from the basket lift (see Figure 21).

31. Use zip ties to secure wires out of the way.

32. Reattach the controller and bezel removed in steps 25 and 26.

34. Reattach the blower and blower power connection removed in steps 9 and 10.



Figure 22



Figure 23

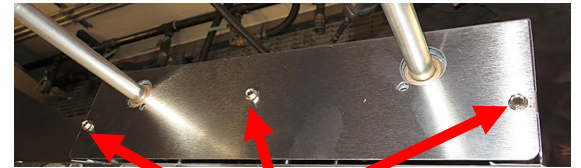

Figure 24

35. Attach the included wiring diagram to the inside of the basketlift cover (see Figure 22).



Figure 25

36. Slide the cover over the basket lift arms (see Figure 23).



Figure 26

37. Attach 3 cabinet screws to the two outer holes and the center hole, on the top of the basketlift cover (see Figure 24).

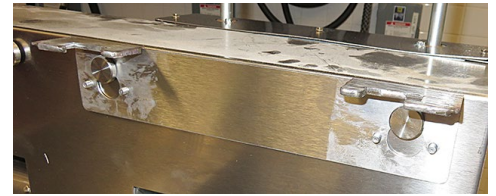

Figure 27

38. Using supplied 8091101 screws, attach to the cover using the two inner holes (see Figure 25).



Figure 28

39. Remove existing basket lift hanger (see Figure 26) and discard. Slide new basket lift bracket over the existing studs (see Figure 27).



Figure 29



Figure 30

40. Attach the new arms into bracket by inserting at a 45 degree angle and placing over the basket lift shaft (see Figures 28 and 29).

41. Insert the baskets into the basket lift arms (see Figure 30).

42. Reconnect power to the fryer.

43. Enable basketlift in vat setup of OCF and FilterQuick fryers. See IO manual for instructions.

44. Turn on fryer and test both sides of the basketlift, ensuring that both arms raise and lower when starting a cook, associated with the basketlift side.

45. Ensure the fryer is repositioned under the hood.

OCF INTERFACE BOARD CONNECTIONS TO BE MADE WHEN ADDING 1083454 FOR OCF MODELS W/BL

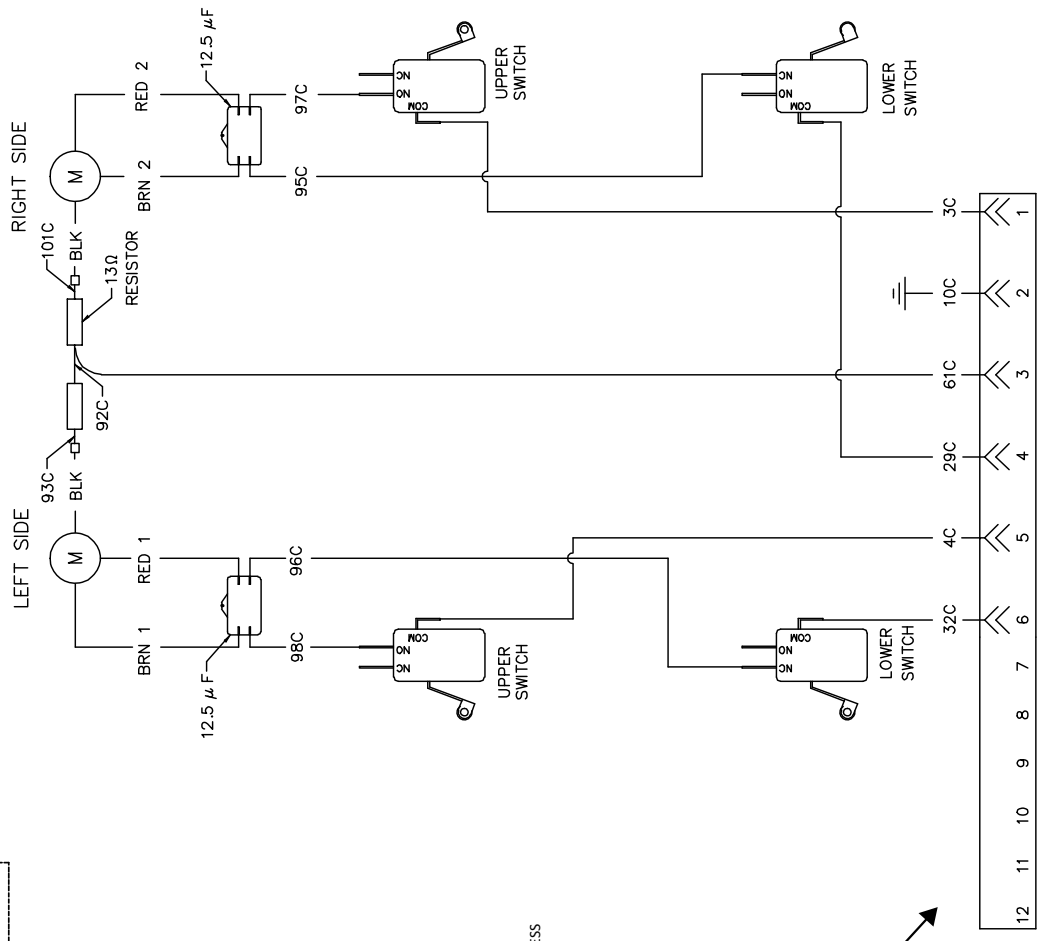
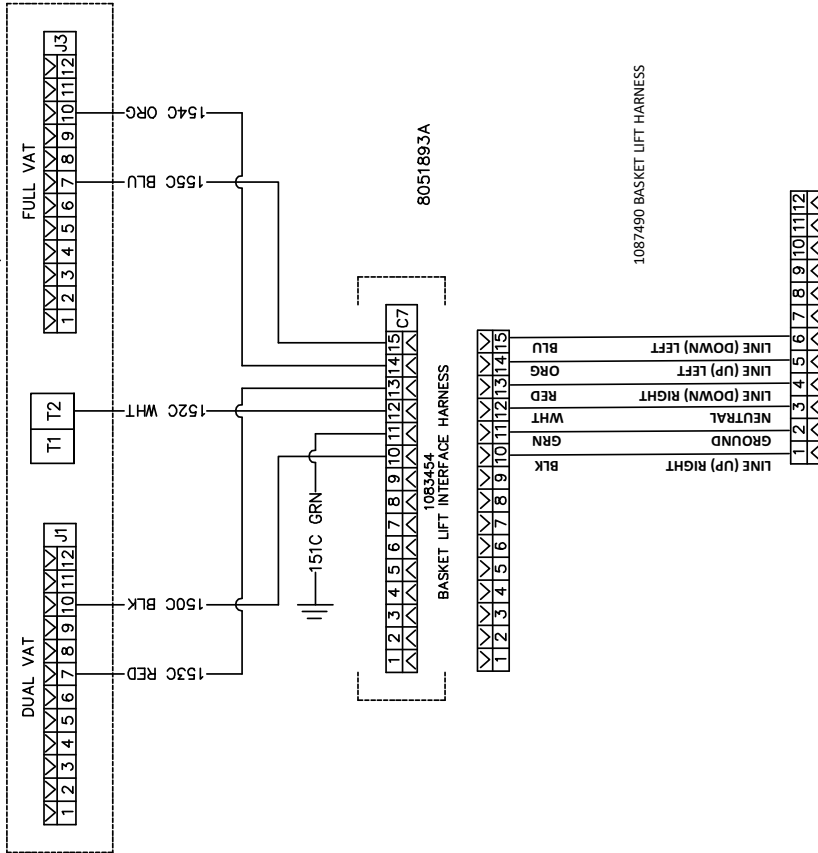

8051893A

1087490 BASKET LIFT HARNESS

REFERENCES TO LEFT AND RIGHT ARE FROM THE REAR OF THE FRYER

8050518F